

TECHNICAL DATA

RATED FLOW [M3/H]	4m3/hr
MAX FLOW	6m3/hr
MAX HEAD	78.7M
OPTIMUM OPERATING RANGE	2.41m3/hr @ 70.6m 39.7% eff
	5m3/hr @ 58.8m 54.4% eff
WORKING AIR TEMP	0°C - 40°C
LIQUID TEMPERATURE	-15°C - 120°C
HIGHEST EFFICIENCY	54.3%
MAXIMUM PUMP PRESSURE	33 bar
NET WEIGHT (KG)	31.2kg

RATED VOLTAGE/CURRENT	Three phase 415V +10% - 6%
RATED CURRENT	3.04 amps
POWER (KW)	1.5kW 2 pole
MOTOR IP RATING	IP55
MOTOR INSULATION	Class F
MOTOR EFFICIENCY STD	I.E.3
MOTOR EFFICIENCY	84.2%
COS Ø	0.84
MECHANICAL SEAL	AS-L-12
OUTLET DIN FLANGE	DN32

DIMENSIONS

HEIGHT A	272
DIAMETER B	166
RADIUS C	135

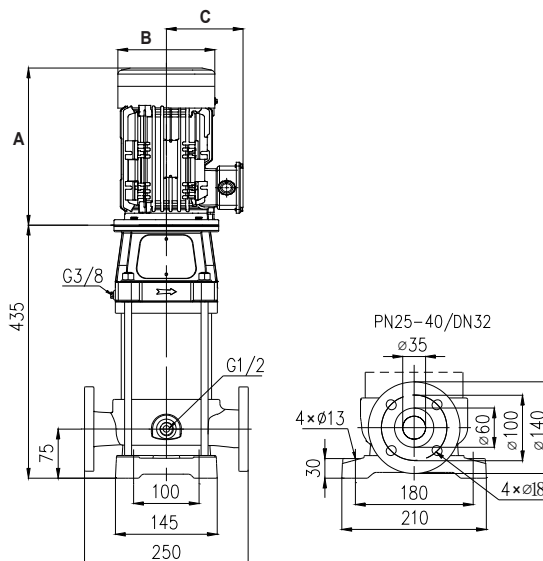

CURVE

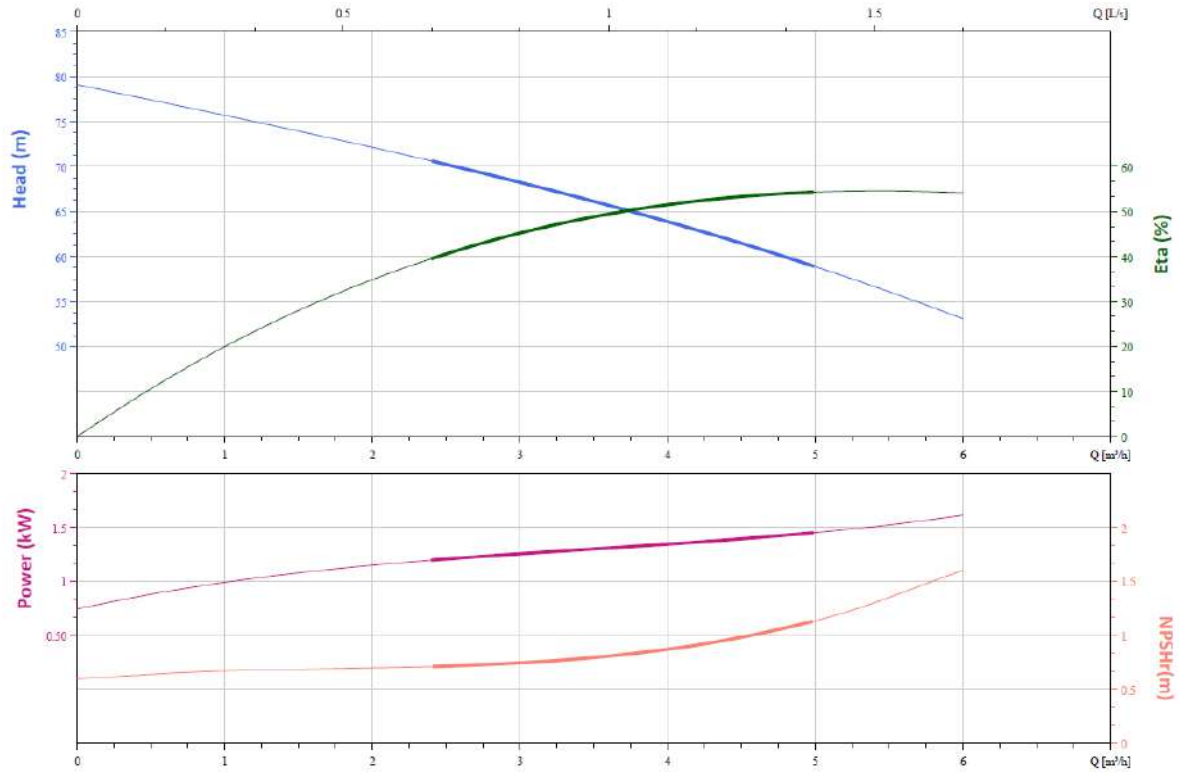

VFD CURVE

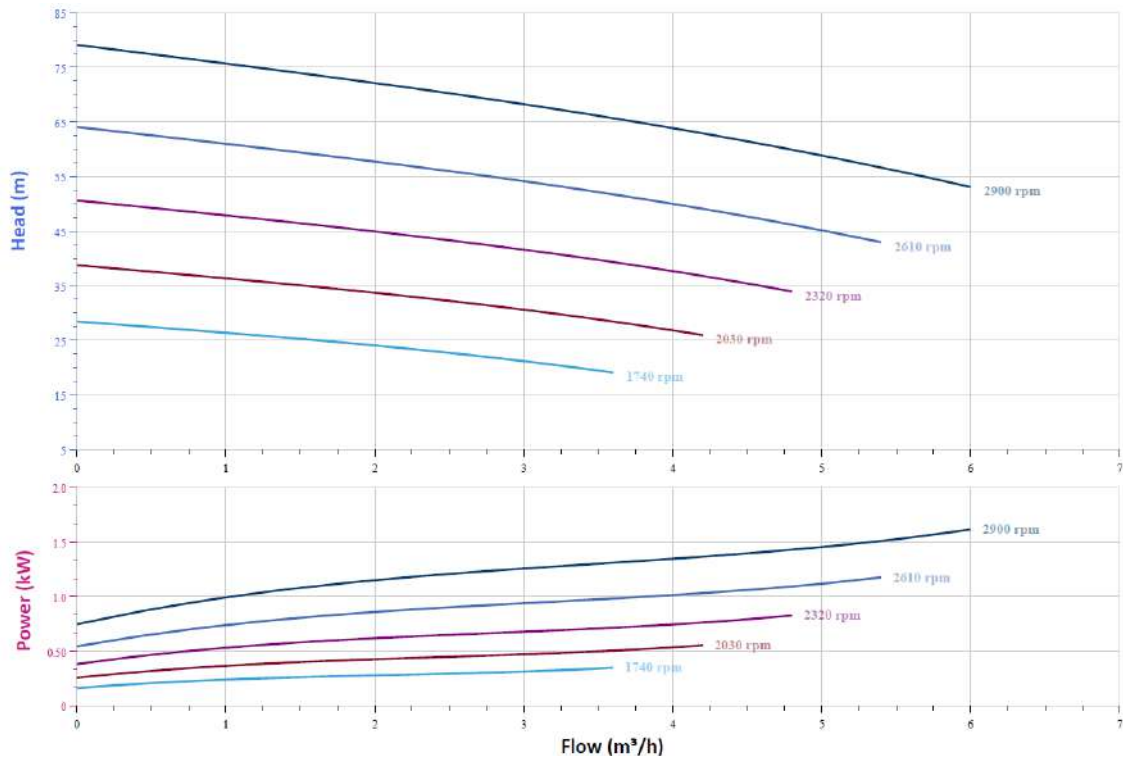

DUAL PUMP CURVE

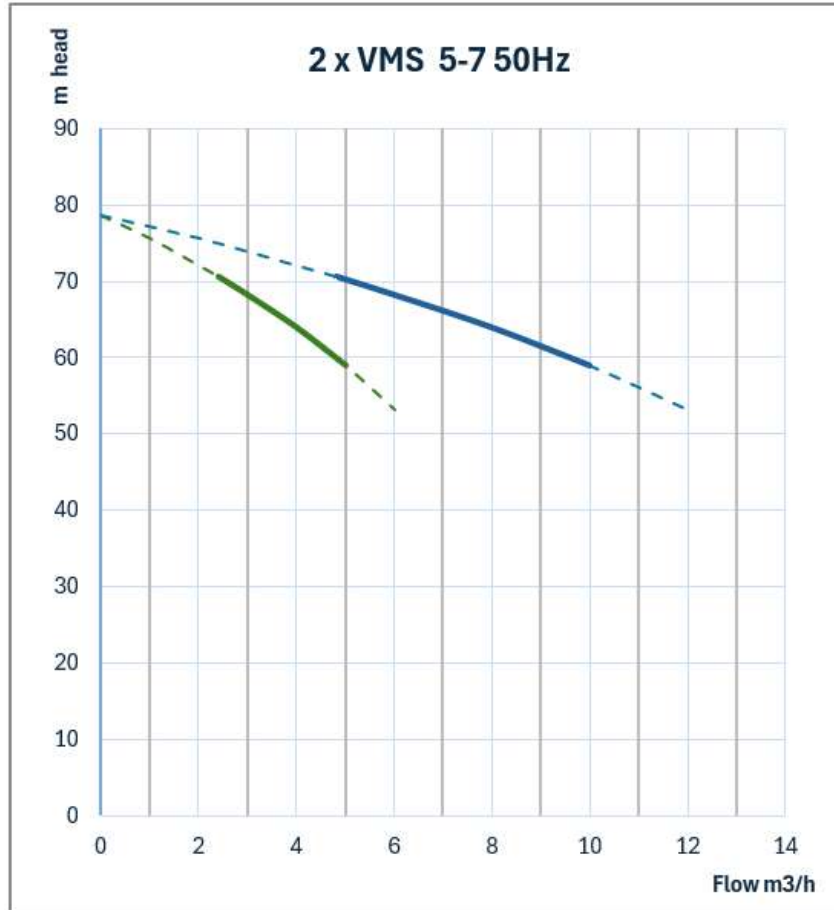

CUTAWAY AND MATERIALS

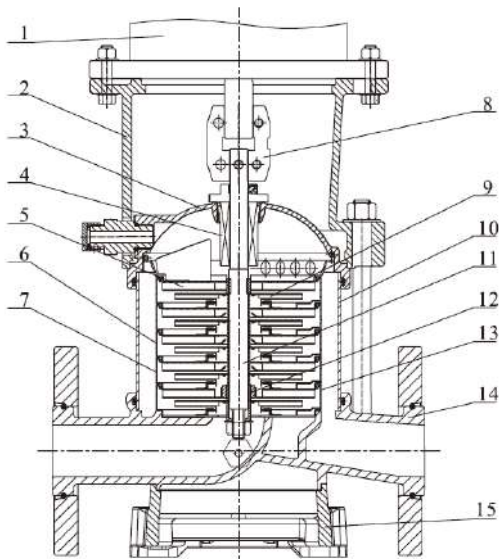

1	Motor	/
2	Bracket	Ductile Cast Iron
3	Seal Base	Stainless / Ductile Cast Iron
4	Mechanical Seal	AS-L-16
5	Top Diffuser	Stainless Steel
6	Diffuser	Stainless Steel
7	Support Diffuser	Stainless Steel
8	Coupling	Stainless Steel
9	Impeller	Stainless Steel
10	Cylinder	Stainless Steel
11	Shaft	Stainless Steel
12	Intermediate Bearing	SIC / WC
13	Inducer	Stainless Steel
14	Inlet/Outlet Chamber	Stainless Steel / Ductile Cast Iron
15	Base	Ductile Cast Iron

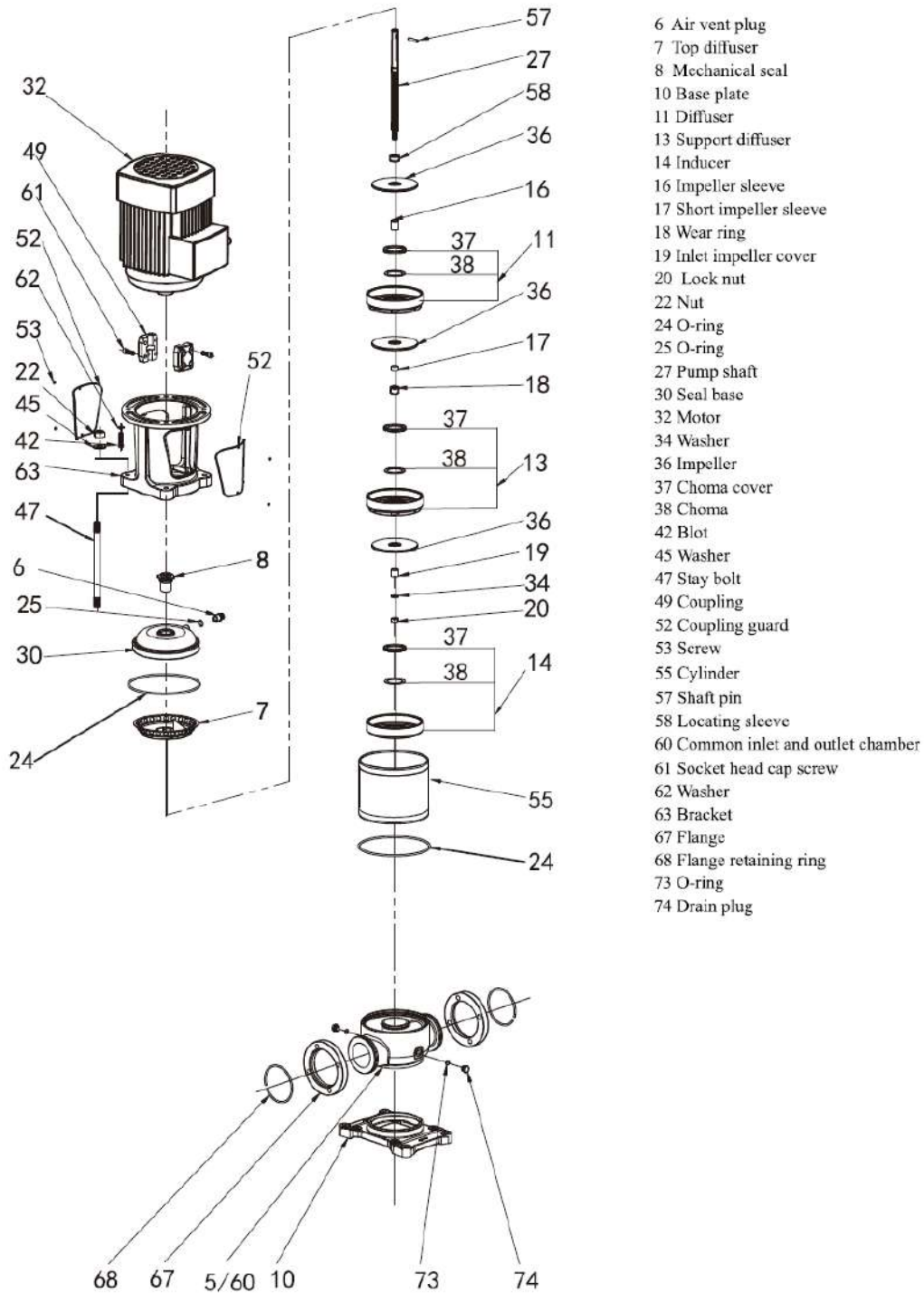

WARRANTY / CERTIFICATIONS

